

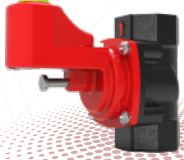

FIYAT LİSTESİ 2023/08



TDV-T					
ÜRÜN İSMİ	SERİ NO	BOYUT	BAĞLANTI	ÇALIŞMA BASINCI	FİYAT
TDV-T 25	MM.19.10	DN 25 (1")	DIŞLI	0-1 BAR	975 ₺
TDV-T 32	MM.19.11	DN 32 (1 1/4")	DIŞLI	0-1 BAR	975 ₺
TDV-T 40	MM.19.12	DN 40 (1 1/2")	DIŞLI	0-1 BAR	975 ₺
TDV-T 50	MM.19.13	DN 50 (2")	DIŞLI	0-1 BAR	975 ₺

DIKEY VE YATAY OLARAK MONTAJLANABİLİR.



TDV-T					
ÜRÜN İSMİ	SERİ NO	BOYUT	BAĞLANTI	ÇALIŞMA BASINCI	FİYAT
TDV-T 65	MM.19.14	DN 65 (2 1/2")	FLANŞLI	0-1 BAR	5.500 ₺
TDV-T 80	MM.19.15	DN 80 (3")	FLANŞLI	0-1 BAR	6.600 ₺
TDV-T 100	MM.19.16	DN 100 (4")	FLANŞLI	0-1 BAR	12.750 ₺

DIKEY VE YATAY OLARAK MONTAJLANABİLİR.

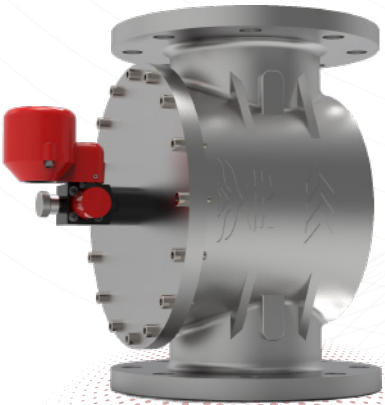

TDV-T					
ÜRÜN İSMİ	SERİ NO	BOYUT	BAĞLANTI	ÇALIŞMA BASINCI	FİYAT
TDV-T 125	MM.19.17	DN 125 (5")	FLANŞLI	0-1 BAR	40.000 ₺
TDV-T 150	MM.19.18	DN 150 (6")	FLANŞLI	0-1 BAR	43.000 ₺
TDV-T 200	MM.19.19	DN 200 (8")	FLANŞLI	0-1 BAR	90.000 ₺
TDV-T 250	MM.19.20	DN 250 (10")	FLANŞLI	0-1 BAR	145.000 ₺
TDV-T 300	MM.19.21	DN 300 (12")	FLANŞLI	0-1 BAR	160.000 ₺

DIKEY VE YATAY OLARAK MONTAJLANABİLİR.



ESV (220-12 VOLT)				FİYAT
ÜRÜN İSMİ	SERİ NO	BOYUT	BAĞLANTI	Pmax: 1 bar
ESV 15	MM.02.10	DN 15 (1/2")	DİŞLİ	650 ₺
ESV 20	MM.02.11	DN 20 (3/4")	DİŞLİ	650 ₺
ESV 25	MM.02.12	DN 25 (1")	DİŞLİ	650 ₺



ESV (220-12 VOLT)				FİYAT
ÜRÜN İSMİ	SERİ NO	BOYUT	BAĞLANTI	Pmax: 1 bar
ESV 32	MM.02.13	DN 32 (1 1/4")	DİŞLİ	1.025 ₺
ESV 40	MM.02.14	DN 40 (1 1/2")	DİŞLİ	1.025 ₺
ESV 50	MM.02.15	DN 50 (2")	DİŞLİ	1.025 ₺



ESV (220-12 VOLT)				FİYAT
ÜRÜN İSMİ	SERİ NO	BOYUT	BAĞLANTI	Pmax: 1 bar
ESV 65	MM.02.16	DN 65 (2 1/2")	FLANŞLI	5.500 ₺
ESV 80	MM.02.17	DN 80 (3")	FLANŞLI	6.600 ₺
ESV 100	MM.02.18	DN 100 (4")	FLANŞLI	12.750 ₺

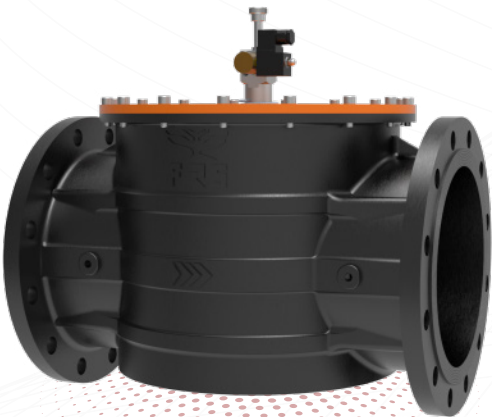

ESV (220-12 VOLT)				FİYAT
ÜRÜN İSMİ	SERİ NO	BOYUT	BAĞLANTI	Pmax: 500 mbar
ESV 125	MM.02.19	DN 125 (5")	FLANŞLI	37.000 ₺
ESV 150	MM.02.20	DN 150 (6")	FLANŞLI	40.000 ₺
ESV 200	MM.02.21	DN 200 (8")	FLANŞLI	88.000 ₺
ESV 250	MM.02.22	DN 250 (10")	FLANŞLI	140.000 ₺
ESV 300	MM.02.23	DN 300 (12")	FLANŞLI	153.000 ₺

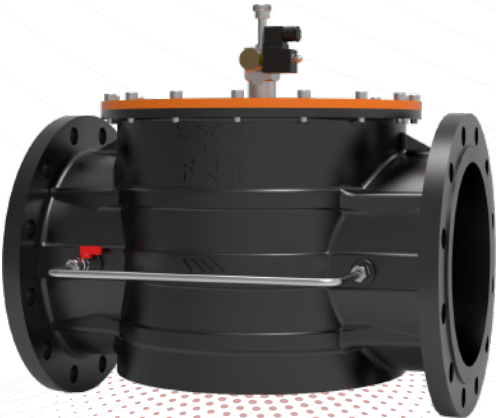

ESV (220-12 VOLT)				FİYAT
ÜRÜN İSMİ	SERİ NO	BOYUT	BAĞLANTI	Pmax: 6 bar
ESV 15	MM.02.10	DN 15 (1/2")	DİŞLİ	2.300 ₺
ESV 20	MM.02.11	DN 20 (3/4")	DİŞLİ	2.300 ₺
ESV 25	MM.02.12	DN 25 (1")	DİŞLİ	2.300 ₺

ESV (220-12 VOLT)				FİYAT
ÜRÜN İSMİ	SERİ NO	BOYUT	BAĞLANTI	Pmax: 6 bar
ESV 32	MM.02.13	DN 32 (1 1/4")	DİŞLİ	2.550 ₺
ESV 40	MM.02.14	DN 40 (1 1/2")	DİŞLİ	2.800 ₺
ESV 50	MM.02.15	DN 50 (2")	DİŞLİ	2.800 ₺

ESV (220-12 VOLT)				FİYAT
ÜRÜN İSMİ	SERİ NO	BOYUT	BAĞLANTI	Pmax: 6 bar
ESV 65	MM.02.16	DN 65 (2 1/2")	FLANŞLI	10.500 ₺
ESV 80	MM.02.17	DN 80 (3")	FLANŞLI	13.750 ₺
ESV 100	MM.02.18	DN 100 (4")	FLANŞLI	23.000 ₺

ESV (220-12 VOLT)				FİYAT
ÜRÜN İSMİ	SERİ NO	BOYUT	BAĞLANTI	Pmax: 6 bar
ESV 125	MM.02.19	DN 125 (5")	FLANŞLI	55.000 ₺
ESV 150	MM.02.20	DN 150 (6")	FLANŞLI	67.000 ₺
ESV 200	MM.02.21	DN 200 (8")	FLANŞLI	145.000 ₺
ESV 250	MM.02.22	DN 250 (10")	FLANŞLI	220.000 ₺
ESV 300	MM.02.23	DN 300 (12")	FLANŞLI	240.000 ₺



FLR				FİYAT
ÜRÜN İSMİ	SERİ NO	BOYUT	BAĞLANTI	P _{max} : 500 mbar
FLR 15	MM.03.10	DN 15 (1/2")	DİŞLİ	500 ₺
FLR 20	MM.03.11	DN 20 (3/4")	DİŞLİ	500 ₺
FLR 25	MM.03.12	DN 25 (1")	DİŞLİ	500 ₺
FLR 32	MM.03.13	DN 32 (1 1/4")	DİŞLİ	750 ₺
FLR 40	MM.03.14	DN 40 (1 1/2")	DİŞLİ	750 ₺
FLR 50	MM.03.15	DN 50 (2")	DİŞLİ	750 ₺



FLR				FİYAT
ÜRÜN İSMİ	SERİ NO	BOYUT	BAĞLANTI	P _{max} : 6 bar
FLR 15	MM.03.10	DN 15 (1/2")	DİŞLİ	-
FLR 20	MM.03.11	DN 20 (3/4")	DİŞLİ	-
FLR 25	MM.03.12	DN 25 (1")	DİŞLİ	600 ₺
FLR 32	MM.03.13	DN 32 (1 1/4")	DİŞLİ	1100 ₺
FLR 40	MM.03.14	DN 40 (1 1/2")	DİŞLİ	1100 ₺
FLR 50	MM.03.15	DN 50 (2")	DİŞLİ	1100 ₺



FLR				FİYAT
ÜRÜN İSMİ	SERİ NO	BOYUT	BAĞLANTI	P _{max} : 6 bar
FLR 65	MM.03.16	DN 65 (2 1/2")	FLANŞLI	5.000 ₺
FLR 80	MM.03.17	DN 80 (3")	FLANŞLI	5.200 ₺
FLR 100	MM.03.18	DN 100 (4")	FLANŞLI	12.500 ₺



FLR				FİYAT
ÜRÜN İSMİ	SERİ NO	BOYUT	BAĞLANTI	P _{max} : 6 bar
FLR 125	MM.03.19	DN 125 (5")	FLANŞLI	18.000 ₺
FLR 150	MM.03.20	DN 150 (6")	FLANŞLI	20.000 ₺
FLR 200	MM.03.21	DN 200 (8")	FLANŞLI	50.000 ₺
FLR 250	MM.03.22	DN 250 (10")	FLANŞLI	65.000 ₺
FLR 300	MM.03.23	DN 300 (12")	FLANŞLI	80.000 ₺



MODEL		BAĞLANTI ÇAPI		MAX GİRİŞ BASINCI							FİYAT	
CAKA 25 HP		Dışlı DN25(1") x DN25(1")		20 BAR								
A	MM.08.10.Y12	50 mbar	0,5	1	2	4	6	10	12	16	19	300 €
	MP	MM.08.10.Y20	300 mbar									
TR	MM.08.10.Y31	500 mbar										360 €
	MM.08.10.Y32	1 bar										
	MM.08.10.Y33	2 bar										
	MM.08.10.Y34	4 bar										

Impulse borusu-sinyal hattı gerekmemektedir.

KAPASİTE TABLOSU (Stm³/h)



MODEL		BAĞLANTI ÇAPI		MAX GİRİŞ BASINCI							FİYAT	
CAKA 25 S		Dışlı DN25(1") x DN40(1 1/2")		20 BAR								
A	MM.08.11.Y11	21 mbar	0,5	1	2	4	6	10	12	16	19	420 €
	MP	MM.08.11.Y20	300 mbar									
TR	MM.08.11.Y31	500 mbar										500 €
		MM.08.11.Y32	1 bar									

Impulse borusu-sinyal hattı gerekmemektedir.

KAPASİTE TABLOSU (Stm³/h)



MODEL		BAĞLANTI ÇAPI		MAX GİRİŞ BASINCI							FİYAT	
CAKA 25		Dışlı DN25(1") x DN40(1 1/2")		20 BAR								
MP	MM.08.12.Y20	300 mbar	0,5	1	2	4	6	10	12	16	19	450 €
	TR	MM.08.12.Y31	500 mbar									
MM.08.12.Y32		1 bar										
MM.08.12.Y33		2 bar										
MM.08.12.Y34		4 bar										

KAPASİTE TABLOSU (Stm³/h)



MODEL		BAĞLANTI ÇAPLI		MAX GİRİŞ BASINCI								Impulse borusu-sinyal hattı gerekmemektedir.	FİYAT
CAKA 40 S (C600) DİŞLİ		DİŞLİ - DN 40(1 1/2") x DN 40(1 1/2")		20 BAR									
A	MM.08.24.Y12	P _{çıkış} / P _{giriş}		0,5	1	2	4	6	10	12	16	19	550 €
		50 mbar	400	600	750	1200	1500	1750	1750	1750	1750	1750	
MM.08.24.Y13	100 mbar	400	600	750	1200	1500	1750	1750	1750	1750	1750	1750	550 €
MM.08.24.Y14	150 mbar	400	600	750	1200	1500	1750	1750	1750	1750	1750		
MP	MM.08.24.Y20	300 mbar	350	620	750	1200	1500	1700	1700	1700	1700	1700	550 €
TR	MM.08.24.Y31	500 mbar	-	580	780	1300	1600	1800	1800	1800	1800	1800	650 €
	MM.08.24.Y32	1 bar	-	-	780	1350	1650	1850	1850	1850	1850	1850	
	MM.08.24.Y33	2 bar	-	-	-	1400	1700	1900	1900	1900	1900	1900	
	MM.08.24.Y34	4 bar	-	-	-	-	1700	1950	1950	1950	1950	1950	

KAPASİTE TABLOSU (Stm³/h)



MODEL		BAĞLANTI ÇAPLI		MAX GİRİŞ BASINCI								Impulse borusu-sinyal hattı gerekmemektedir.	FİYAT
CAKA 50 S (C600) DİŞLİ		DİŞLİ - DN 50(2") x DN 50(2")		20 BAR									
A	MM.08.32.Y12	P _{çıkış} / P _{giriş}		0,5	1	2	4	6	10	12	16	19	700 €
		50 mbar	480	720	900	1400	1800	2100	2100	2100	2100	2100	
MM.08.32.Y13	100 mbar	480	720	900	1400	1800	2100	2100	2100	2100	2100	2100	700 €
MM.08.32.Y14	150 mbar	480	720	900	1400	1800	2100	2100	2100	2100	2100		
MP	MM.08.32.Y20	300 mbar	420	720	900	1400	1800	2000	2000	2000	2000	2000	700 €
TR	MM.08.32.Y31	500 mbar	-	700	930	1300	1900	2150	2150	2150	2150	2150	950 €
	MM.08.32.Y32	1 bar	-	-	930	1550	1980	2200	2500	2500	2500	2500	
	MM.08.32.Y33	2 bar	-	-	-	1650	2500	2900	3000	3000	3000	3000	
	MM.08.32.Y34	4 bar	-	-	-	-	2500	3250	3500	3500	3500	3500	

KAPASİTE TABLOSU (Stm³/h)



MODEL	BAĞLANTI ÇAPI		MAX GİRİŞ BASINCI								FİYAT	
	FLANŞLI DN 25(1") x DN 25(1")		20 BAR									
CAKA 25	$p_{\text{çıkış}}$	$p_{\text{giriş}}$	0,5	1	2	4	6	10	12	16	19	
MP	MM.08.13.Y20	300 mbar	180	280	325	525	700	700	700	700	700	500 €
TR	MM.08.13.Y31	500 mbar	-	250	325	525	700	700	700	700	700	550 €
	MM.08.13.Y32	1 bar	-	-	275	475	625	700	700	700	700	
	MM.08.13.Y33	2 bar	-	-	-	400	550	675	700	700	700	
	MM.08.13.Y34	4 bar	-	-	-	-	500	675	725	725	725	

KAPASİTE TABLOSU (Stm³/h)



MODEL	BAĞLANTI ÇAPI		BAĞLANTI TİPİ								MAX GİRİŞ BASINCI	FİYAT
	FLANŞLI - DN 40(1 1/2") x DN 40(1 1/2")		PN 16 - ANSI 150									
CAKA 40 S (C600) FLANŞLI	$p_{\text{çıkış}}$	$p_{\text{giriş}}$	0,5	1	2	4	6	10	12	16	19	
A	MM.08.22.Y12	50 mbar	400	600	750	1200	1500	1750	1750	1750	1750	1.000 €
	MM.08.22.Y13	100 mbar	400	600	750	1200	1500	1750	1750	1750	1750	
	MM.08.22.Y14	150 mbar	400	600	750	1200	1500	1750	1750	1750	1750	
MP	MM.08.22.Y20	300 mbar	350	620	750	1200	1500	1700	1700	1700	1700	1.000 €
TR	MM.08.22.Y31	500 mbar	-	580	780	1300	1600	1800	1800	1800	1800	1.000 €
	MM.08.22.Y32	1 bar	-	-	780	1350	1650	1850	1850	1850	1850	
	MM.08.22.Y33	2 bar	-	-	-	1400	1700	1900	1900	1900	1900	
	MM.08.22.Y34	4 bar	-	-	-	-	1700	1950	1950	1950	1950	

Impulse borusu-sinyal hatlı gerekmemektedir.

KAPASİTE TABLOSU (Stm³/h)



MODEL	BAĞLANTI ÇAPI		BAĞLANTI TİPİ								MAX GİRİŞ BASINCI	FİYAT
	FLANŞLI - DN 50(2") x DN 50(2")		PN 16 - ANSI 150									
CAKA 50 S (C600) FLANŞLI	$p_{\text{çıkış}}$	$p_{\text{giriş}}$	0,5	1	2	4	6	10	12	16	19	
A	MM.08.31.Y12	50 mbar	480	720	900	1400	1800	2100	2100	2100	2100	1.100 €
	MM.08.31.Y13	100 mbar	480	720	900	1400	1800	2100	2100	2100	2100	
	MM.08.31.Y14	150 mbar	480	720	900	1400	1800	2100	2100	2100	2100	
MP	MM.08.31.Y20	300 mbar	420	720	900	1400	1800	2000	2000	2000	2000	1.100 €
TR	MM.08.31.Y31	500 mbar	-	700	930	1300	1900	2150	2150	2150	2150	1.100 €
	MM.08.31.Y32	1 bar	-	-	930	1550	1980	2200	2500	2500	2500	
	MM.08.31.Y33	2 bar	-	-	-	1650	2500	2900	3000	3000	3000	
	MM.08.31.Y34	4 bar	-	-	-	-	2500	3250	3500	3500	3500	

Impulse borusu-sinyal hatlı gerekmemektedir.

KAPASİTE TABLOSU (Stm³/h)



MODEL		BAĞLANTI ÇAPI		BAĞLANTI TİPİ							MAX GİRİŞ BASINCI	
CAKA 40		FLANŞLI - DN 40(1 1/2") x DN 40(1 1/2")		PN 16 - ANSI 150							20 BAR	
		$\frac{P_{\text{çıkış}}}{P_{\text{giriş}}}$	0,5	1	2	4	6	10	12	16	19	FİYAT
A	MM.08.20.Y12	50 mbar	400	650	750	1200	1700	1700	1700	1700	1700	900 €
	MM.08.20.Y13	100 mbar	400	650	750	1200	1700	1700	1700	1700	1700	
	MM.08.20.Y14	150 mbar	400	650	750	1200	1700	1700	1700	1700	1700	
MP	MM.08.20.Y20	300 mbar	300	700	850	1450	1800	1800	1800	1800	1800	900 €
TR	MM.08.20.Y31	500 mbar	-	600	850	1450	1800	1800	1800	1800	1800	1.000 €
	MM.08.20.Y32	1 bar	-	-	750	1450	2000	2250	2250	2250	2250	
	MM.08.20.Y33	2 bar	-	-	-	1450	2000	2400	2400	2400	2400	
	MM.08.20.Y34	4 bar	-	-	-	-	2000	2600	3000	3000	3000	

KAPASİTE TABLOSU (Stm³/h)



MODEL		BAĞLANTI ÇAPI		BAĞLANTI TİPİ							MAX GİRİŞ BASINCI	
CAKA 50		FLANŞLI - DN 50(2") x DN 50(2")		PN 16 - ANSI 150							20 BAR	
		$\frac{P_{\text{çıkış}}}{P_{\text{giriş}}}$	0,5	1	2	4	6	10	12	16	19	FİYAT
A	MM.08.30.Y12	50 mbar	600	975	1125	1800	2550	2550	2550	2550	2550	1850 €
	MM.08.30.Y13	100 mbar	600	975	1125	1800	2550	2550	2550	2550	2550	
	MM.08.30.Y14	150 mbar	600	975	1125	1800	2550	2550	2550	2550	2550	
MP	MM.08.30.Y20	300 mbar	450	1100	1275	2200	2700	2700	2700	2700	2700	1850 €
TR	MM.08.30.Y31	500 mbar	-	900	1275	2200	2700	2700	2700	2700	2700	2250 €
	MM.08.30.Y32	1 bar	-	-	1125	2550	3250	3800	3800	3800	3800	
	MM.08.30.Y33	2 bar	-	-	-	2550	3250	4000	4000	4000	4000	
	MM.08.30.Y34	4 bar	-	-	-	-	3250	4500	5000	5000	5000	

KAPASİTE TABLOSU (Stm³/h)



MODEL	BAĞLANTI ÇAPI	BAĞLANTI TİPİ		MAX GİRİŞ BASINCI								
CAKA 80	FLANŞLI DN 80(3") x DN 80(3")	PN 16 - ANSI 150		20 BAR								
	$P_{çıkış} / P_{giriş}$	0,5	1	2	4	6	10	12	16	19	FİYAT	
A	MM.08.40.Y11	21 mbar	2200	2900	4100	5950	6500	6750	6750	6750	6750	2900 €
	MM.08.40.Y12	50 mbar	2200	2900	4100	5950	6500	6750	6750	6750	6750	
	MM.08.40.Y13	100 mbar	2200	2900	4100	5950	6500	6750	6750	6750	6750	
	MM.08.40.Y14	150 mbar	1750	3050	4500	6750	7750	8100	8100	8100	8100	
MP	MM.08.40.Y20	300 mbar	1750	3050	4500	6750	7750	8100	8100	8100	8100	2900 €
	MM.08.40.Y31	500 mbar	-	2700	4000	6750	8800	9950	9950	9950	9950	2900 €
TR	MM.08.40.Y32	1 bar	-	-	3000	6500	8800	9950	9950	9950	9950	
	MM.08.40.Y33	2 bar	-	-	-	5500	9850	11800	12500	15100	15100	
	MM.08.40.Y34	4 bar	-	-	-	-	8500	12750	14100	15100	15500	

KAPASİTE TABLOSU (Stm³/h)



MODEL	BAĞLANTI ÇAPI	BAĞLANTI TİPİ		MAX GİRİŞ BASINCI								
CAKA 100	FLANŞLI DN 100(4") x DN 100(4")	PN 16 - ANSI 150		20 BAR								
	$P_{çıkış} / P_{giriş}$	0,5	1	2	4	6	10	12	16	19	FİYAT	
A	MM.08.50.Y11	21 mbar	2970	3910	5530	8030	8770	9110	9110	9110	9110	4700 €
	MM.08.50.Y12	50 mbar	2970	3910	5530	8030	8770	9110	9110	9110	9110	
	MM.08.50.Y13	100 mbar	2970	3910	5530	8030	8770	9110	9110	9110	9110	
	MM.08.50.Y14	150 mbar	2350	4110	6070	8950	10460	10530	10530	10530	10530	
MP	MM.08.50.Y20	300 mbar	2350	4110	6070	8950	10460	10530	10530	10530	10530	4700 €
	MM.08.50.Y31	500 mbar	-	3640	5400	8950	11880	13430	13430	13430	13430	4700 €
TR	MM.08.50.Y32	1 bar	-	-	4050	8770	11880	13430	13430	13430	13430	
	MM.08.50.Y33	2 bar	-	-	-	7420	13290	15930	16870	20380	20920	
	MM.08.50.Y34	4 bar	-	-	-	-	11470	17210	19030	20380	20920	

KAPASİTE TABLOSU (Stm³/h)



MODEL	BAĞLANTI ÇAPI		MAX GİRİŞ BASINCI					FİYAT
FRG-YB 25	DİŞLİ DN 25(1") x DN 25(1")		5 BAR					
	$P_{\text{çıkış}} / P_{\text{giriş}}$	0,5	1	2	3	4	5	5.000 ₺
MM.01.31.01.10	21 mbar	100	150	180	200	200	200	
MM.01.31.01.20	50 mbar	100	150	200	225	250	250	
MM.01.31.01.30	100 mbar	80	120	200	250	300	300	
MM.01.31.01.40	300 mbar	60	110	200	250	400	400	

KAPASİTE TABLOSU (Stm³/h)

MODEL	BAĞLANTI ÇAPI		MAX GİRİŞ BASINCI					FİYAT
FRG-YB 32	DİŞLİ DN 32(1 1/4") x DN 32(1 1/4")		5 BAR					
	$P_{\text{çıkış}} / P_{\text{giriş}}$	0,5	1	2	3	4	5	11.000 ₺
MM.01.32.01.10	21 mbar	270	430	450	450	450	450	
MM.01.32.01.20	50 mbar	270	410	600	620	620	620	
MM.01.32.01.30	100 mbar	250	400	650	740	740	740	
MM.01.32.01.40	300 mbar	190	370	650	890	940	940	

KAPASİTE TABLOSU (Stm³/h)

MODEL	BAĞLANTI ÇAPI		MAX GİRİŞ BASINCI					FİYAT
FRG-YB 40	DİŞLİ DN 40(1 1/2") x DN 40(1 1/2")		5 BAR					
	$P_{\text{çıkış}} / P_{\text{giriş}}$	0,5	1	2	3	4	5	11.000 ₺
MM.01.33.01.10	21 mbar	270	430	690	700	700	700	
MM.01.33.01.20	50 mbar	270	430	700	860	870	890	
MM.01.33.01.30	100 mbar	260	420	690	950	1050	1070	
MM.01.33.01.40	300 mbar	190	380	670	940	1160	1380	

KAPASİTE TABLOSU (Stm³/h)

MODEL	BAĞLANTI ÇAPI		MAX GİRİŞ BASINCI					FİYAT
FRG-YB 50	DİŞLİ DN 50(2") x DN 50(2")		5 BAR					
	$P_{\text{çıkış}} / P_{\text{giriş}}$	0,5	1	2	3	4	5	11.750 ₺
MM.01.34.01.10	21 mbar	300	460	750	990	1290	1500	
MM.01.34.01.20	50 mbar	300	460	750	1000	1300	1500	
MM.01.34.01.30	100 mbar	280	450	740	1000	1300	1500	
MM.01.34.01.40	300 mbar	210	390	700	960	1250	1500	

KAPASİTE TABLOSU (Stm³/h)



FRG - DÜZ						
ÜRÜN İSMİ	SERİ NO	BOYUT	BAĞLANTI	P _{max}	P _{out}	FİYAT
FRG 15	MM.01.21.02	DN 15 (1/2")	DİŞLİ	1 bar	21-300 mbar	1.500 ₺
FRG 20	MM.01.22.02	DN 20 (3/4")	DİŞLİ	1 bar	21-300 mbar	1.500 ₺
FRG 25	MM.01.23.02	DN 25 (1")	DİŞLİ	1 bar	21-300 mbar	1.500 ₺
FRG 32	MM.01.24.02	DN 32 (1 1/4")	DİŞLİ	1 bar	21-300 mbar	3.500 ₺
FRG 40	MM.01.25.02	DN 40 (1 1/2")	DİŞLİ	1 bar	21-300 mbar	3.500 ₺
FRG 50	MM.01.26.02	DN 50 (2")	DİŞLİ	1 bar	21-300 mbar	3.700 ₺



FRG + SSV						
ÜRÜN İSMİ	SERİ NO	BOYUT	BAĞLANTI	P _{max}	P _{out}	FİYAT
FRG-SSV 15	MM.01.21.01	DN 15 (1/2")	DİŞLİ	1 bar	21-300 mbar	1.900 ₺
FRG-SSV 20	MM.01.22.01	DN 20 (3/4")	DİŞLİ	1 bar	21-300 mbar	1.900 ₺
FRG-SSV 25	MM.01.23.01	DN 25 (1")	DİŞLİ	1 bar	21-300 mbar	1.900 ₺
FRG-SSV 32	MM.01.24.01	DN 32 (1 1/4")	DİŞLİ	1 bar	21-300 mbar	3.750 ₺
FRG-SSV 40	MM.01.25.01	DN 40 (1 1/2")	DİŞLİ	1 bar	21-300 mbar	3.750 ₺
FRG-SSV 50	MM.01.26.01	DN 50 (2")	DİŞLİ	1 bar	21-300 mbar	3.850 ₺



FRG - DÜZ						
ÜRÜN İSMİ	SERİ NO	BOYUT	BAĞLANTI	P _{max}	P _{out}	FİYAT
FRG 65	MM.01.51.02	DN 65 (2 1/2")	FLANŞLI	500 mbar	21-300 mbar	11.000 ₺
FRG 80	MM.01.52.02	DN 80 (3")	FLANŞLI	500 mbar	21-300 mbar	11.500 ₺
FRG 100	MM.01.53.02	DN 100 (4")	FLANŞLI	500 mbar	21-300 mbar	17.000 ₺

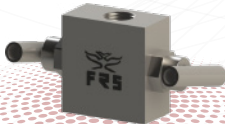
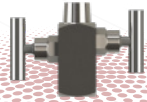
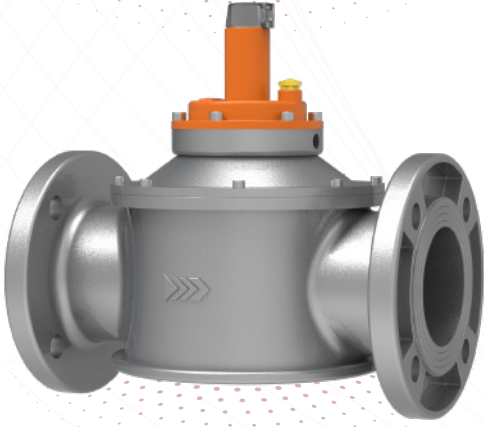

EKV - EMNİYET KAPATMA VANASI

ÜRÜN İSMİ	SERİ NO	BOYUT	BAĞLANTI	FİYAT
EKV 15	MM.05.04.02	DN 15 (1/2")	DİŞLİ	3.400 ₺
EKV 20	MM.05.05.02	DN 20 (3/4")	DİŞLİ	3.400 ₺
EKV 25	MM.05.06.02	DN 25 (1")	DİŞLİ	3.400 ₺

EKV - EMNİYET KAPATMA VANASI

ÜRÜN İSMİ	SERİ NO	BOYUT	BAĞLANTI	FİYAT
EKV 32	MM.05.07.02	DN 32 (1 1/4")	DİŞLİ	4.150 ₺
EKV 40	MM.05.08.02	DN 40 (1 1/2")	DİŞLİ	4.150 ₺
EKV 50	MM.05.09.02	DN 50 (2")	DİŞLİ	5.500 ₺

EKV - EMNİYET KAPATMA VANASI

ÜRÜN İSMİ	SERİ NO	BOYUT	BAĞLANTI	FİYAT
EKV 65	MM.05.10.01	DN 65 (2 1/2")	FLANŞLI	6.750 ₺
EKV 80	MM.05.11.01	DN 80 (3")	FLANŞLI	7.750 ₺
EKV 100	MM.05.12.01	DN 100 (4")	FLANŞLI	8.750 ₺

MDV - CL 800 PASLANMAZ İĞNE VANA

ÜRÜN İSMİ	SERİ NO	BOYUT	BAĞLANTI	FİYAT
MDV-2	MM.14.10	DN 15 (1/2")	DİŞLİ (NPT)	112,50 €

MDV - CL 800 PASLANMAZ VANA

ÜRÜN İSMİ	SERİ NO	BOYUT	BAĞLANTI	FİYAT
MDV-3	MM.14.20	DN 15 (1/2")	DİŞLİ (NPT)	137,50 €



ETH-M RELIEF

ÜRÜN İSMİ	SERİ NO	BOYUT	BAĞLANTI	SET BASINCI	FİYAT
ETH-M 25	MM.06.11	DN 25 (1")	Dışlı	21-1000 mbar	2.000 ₺



ETH RELIEF

ÜRÜN İSMİ	SERİ NO	BOYUT	BAĞLANTI	SET BASINCI	FİYAT
ETH 25	MM.06.12	DN 25 (1")	Dışlı	21-1000 mbar	2.500 ₺



ETV-M RELIEF

ÜRÜN İSMİ	SERİ NO	BOYUT	BAĞLANTI	SET BASINCI	FİYAT
ETV-M 25	MM.06.20	DN 25 (1")	Dışlı	2-6 bar	300 €



ETA RELIEF

ÜRÜN İSMİ	SERİ NO	BOYUT	BAĞLANTI	SET BASINCI	FİYAT
ETA 25	MM.06.30	DN 25 (1")	Dışlı	4-40 bar	350 €



CSR					
Bağlantı Çapı 3/4" - 1" x 1" - 1 1/4" - 1 1/2"					
ÜRÜN İSMİ	SERİ NO	P _{max}	P _{out}	KAPASİTE	FİYAT
CSR 6-25	-	5 bar	21-150 mbar	6-25 m ³ /h	92 €
CSR 6-25	-	5 bar	150-300 mbar	6-25 m ³ /h	92 €
CSR 50	-	5 bar	21-150 mbar	50 m ³ /h	115 €
CSR 50	-	5 bar	150-300 mbar	50 m ³ /h	115 €



CEX					
Bağlantı Çapı 1" x 1 1/2"					
ÜRÜN İSMİ	SERİ NO	P _{max}	P _{out}	KAPASİTE	FİYAT
CEX 75	-	5 bar	21-150 mbar	75 m ³ /h	150 €
CEX 75	-	5 bar	150-300 mbar	75 m ³ /h	150 €
CEX 100	-	5 bar	21-150 mbar	100 m ³ /h	165 €
CEX 100	-	5 bar	150-300 mbar	100 m ³ /h	175 €

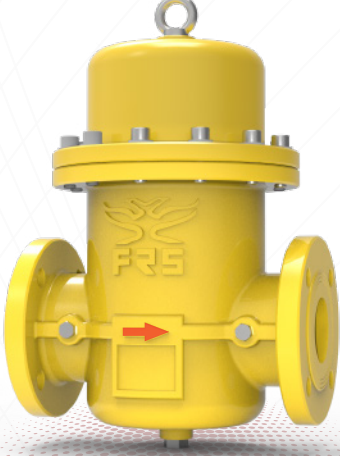

FLR-D DÖKÜM FİLTRE						PN 16
ÜRÜN İSMİ	SERİ NO	BOYUT	KARTUŞ TİPİ	FİLTASYON (μ)	FİLTASYON ALANI (m ²)	FİYAT
FLR-D 25	MM.07.10	DN 25	G 0.5	2-5-10	0,06	310 €
FLR-D 32	MM.07.11	DN 32	G 0.5	2-5-10	0,06	320 €
FLR-D 40	MM.07.12	DN 40	G 0.5	2-5-10	0,06	330 €
FLR-D 50	MM.07.13	DN 50	G 0.5	2-5-10	0,06	340 €
FLR-D 65	MM.07.14	DN 65	G 1.5	2-5-10	0,23	660 €
FLR-D 80	MM.07.15	DN 80	G 1.5	2-5-10	0,23	675 €
FLR-D 100	MM.07.16	DN 100	G 1.5	2-5-10	0,23	690 €



FF SERİSİ ÇELİK FİLTRE					PN 16 - ANSI 150
ÜRÜN İSMİ	SERİ NO	BOYUT	KARTUŞ TİPİ	FİLTASYON (μ)	FİYAT
FF/A 20	-	DN 20	G 0.5	2-5-10	550 €
FF/A 25	-	DN 25	G 0.5	2-5-10	550 €
FF/A 32	-	DN 32	G 0.5	2-5-10	565 €
FF/A 40	-	DN 40	G 0.5	2-5-10	565 €
FF/A 50	-	DN 50	G 1	2-5-10	580 €
FF/A 65	-	DN 65	G 1	2-5-10	675 €
FF/A 80	-	DN 80	G 1.5	2-5-10	1.150 €
FF/A 100	-	DN 100	G 2	2-5-10	1.320 €
FF/A 125	-	DN 125	G 2.5	2-5-10	4.400 €
FF/A 150	-	DN 150	G 2.5	2-5-10	4.500 €
FF/A 150	-	DN 150	G 3	2-5-10	4.800 €
FF/A 200	-	DN 200	G 3	2-5-10	7.000 €

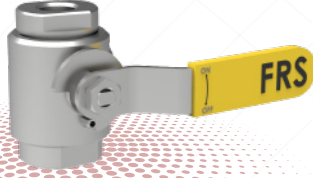

CL 800 ÇELİK KÜRESEL VANA				
ÜRÜN İSMİ	SERİ NO	BOYUT	BAĞLANTI	FİYAT
DN 8	MM.13.01.02.02	DN 8 (1/4")	DIŞLI	1.150 ₺
DN 15	MM.13.02.02.02	DN 15 (1/2")	DIŞLI	1.150 ₺
DN 25	MM.13.03.02.02	DN 25 (1")	DIŞLI	1.750 ₺
DN 50	MM.13.06.02.02	DN 50 (2")	DIŞLI	FİYAT SORUNUZ

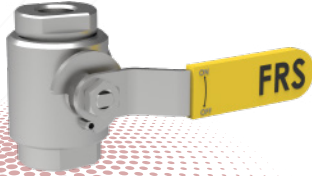

CL 800 - CL 1500 DIŞLI PASLANMAZ ÇELİK KÜRESEL VANA				
ÜRÜN İSMİ	SERİ NO	BOYUT	BAĞLANTI	FİYAT
DN 8	MM.13.01.03.02	DN 8 (1/4")	DIŞLI	50 €
DN 15	MM.13.02.03.02	DN 15 (1/2")	DIŞLI	50 €
DN 25	MM.13.03.03.02	DN 25 (1")	DIŞLI	80 €
DN 50	MM.13.06.03.02	DN 50 (2")	DIŞLI	FİYAT SORUNUZ

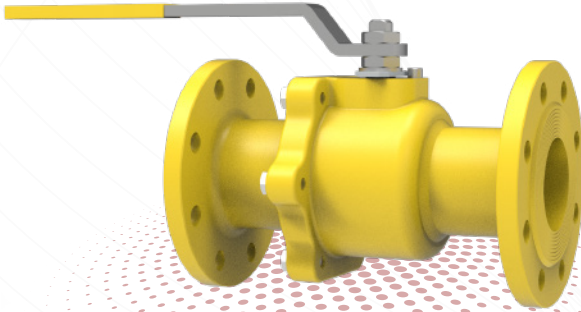

FLANŞLI KÜRESEL VANALAR				
ÜRÜN İSMİ	SERİ NO	BOYUT	BAĞLANTI	FİYAT
DN 25	MM.13.03.01.02	DN 25 (1")	FLANŞLI	2.500 ₺
DN 32	MM.13.04.01.02	DN 32 (1 1/4")	FLANŞLI	3.200 ₺
DN 40	MM.13.05.01.02	DN 40 (1 1/2")	FLANŞLI	3.400 ₺
DN 50	MM.13.06.01.02	DN 50 (2")	FLANŞLI	4.000 ₺
DN 65	MM.13.07.01.02	DN 65 (2 1/2")	FLANŞLI	6.000 ₺
DN 80	MM.13.08.01.02	DN 80 (3")	FLANŞLI	8.000 ₺
DN 100	MM.13.09.01.02	DN 100 (4")	FLANŞLI	12.000 ₺



FLANŞLI KÜRESEL VANALAR				
ÜRÜN İSMİ	SERİ NO	BOYUT	BAĞLANTI	FİYAT
DN 150	MM.13.10.01.02	DN 150 (6")	FLANŞLI	29.000 ₺
DN 200	MM.13.11.01.02	DN 200 (8")	FLANŞLI	46.000 ₺
DN 250	MM.13.12.01.02	DN 250 (10")	FLANŞLI	110.000 ₺
DN 300	MM.13.13.01.02	DN 300 (12")	FLANŞLI	240.000 ₺

GEARBOX DAHİL

GEARBOX DAHİL

! GEARBOX EKLENTİ FİYATI: 4.000 ₺



MODEL	BAĞLANTI ÇAPI	MAX GİRİŞ BASINCI	ÇALIŞMA SICAKLIĞI					FİYAT
CNG 15	DN 15(1/2") x DN 15(1/2") NPT	250 BAR	-30°C / +60°C					750 €
	$\frac{p_{giris} (bar)}{p_{cikis} (bar)}$	25	50	100	150	200		
MM.12.10.00	5-40	300	400	450	500	550		

KAPASİTE TABLOSU (Stm³/h)



MODEL	BAĞLANTI ÇAPI	MAX GİRİŞ BASINCI	ÇALIŞMA SICAKLIĞI					FİYAT
CNG 25	DN25(1") x DN25(1") NPT	250 BAR	-30°C / +60°C					1.050 €
	$\frac{p_{giris} (bar)}{p_{cikis} (bar)}$	25	50	100	150	200		
MM.12.20.00	5-40	700	1000	1250	1500	2000		

KAPASİTE TABLOSU (Stm³/h)



MODEL	BAĞLANTI ÇAPI	MAX GİRİŞ BASINCI	ÇALIŞMA SICAKLIĞI					FİYAT
CNG 40	DN40(1 1/2") x DN40(1 1/2") NPT	250 BAR	-30°C / +60°C					1.500 €
	$\frac{p_{giris} (bar)}{p_{cikis} (bar)}$	25	50	100	150	200		
MM.12.30.00	5-40	900	1300	1600	2000	2600		

KAPASİTE TABLOSU (Stm³/h)

Giriş-Çıkış Manometresi

FİYAT: 10 € / Adet

Giriş-Çıkış Bağlantı Rekoru

FİYAT: 25 € / Adet

Yedek Sinter Filtre

FİYAT: 35 € / Adet

! CNG Regülatörü devreye alınırken regülatör giriş basıncı kontrollü bir şekilde yavaş yavaş yükseltilmelidir.

CNG Regülatörün filtresi kullanıma göre belirli aralıklarla temizlenmelidir.

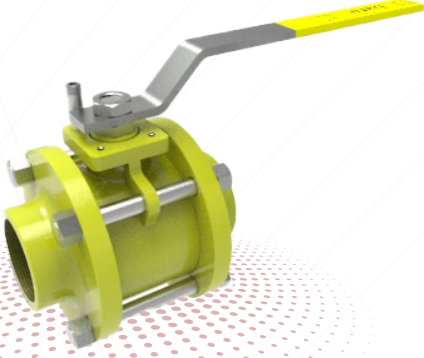

BATU - DIŞLI ÇELİK SFERO DÖKÜM KÜRESEL VANALAR

ÜRÜN	BOYUT	BAĞLANTI	BASINÇ	FİYAT
DN 15	DN 25 (1")	DIŞLI	MOP 5-20	957 ₺
DN 20	DN 32 (1 1/4")	DIŞLI	MOP 5-20	1.065 ₺
DN 25	DN 25 (1")	DIŞLI	MOP 5-20	1.293 ₺
DN 32	DN 32 (1 1/4")	DIŞLI	MOP 5-20	1.832 ₺
DN 40	DN 40 (1 1/2")	DIŞLI	MOP 5-20	2.159 ₺
DN 50	DN 50 (2")	DIŞLI	MOP 5-20	2.851 ₺

BATU - FLANŞLI KÜRESEL VANALAR

ÜRÜN	BOYUT	BAĞLANTI	BASINÇ	FİYAT
DN 15	DN 25 (1")	FLANŞLI	PN 16	1.392 ₺
DN 20	DN 32 (1 1/4")	FLANŞLI	PN 16	1.718 ₺
DN 25	DN 25 (1")	FLANŞLI	PN 16	1.976 ₺
DN 32	DN 32 (1 1/4")	FLANŞLI	PN 16	2.628 ₺
DN 40	DN 40 (1 1/2")	FLANŞLI	PN 16	2.998 ₺
DN 50	DN 50 (2")	FLANŞLI	PN 16	3.773 ₺
DN 65	DN 65 (2 1/2")	FLANŞLI	PN 16	5.064 ₺
DN 80	DN 80 (3")	FLANŞLI	PN 16	7.187 ₺
DN 100	DN 100 (4")	FLANŞLI	PN 16	9.882 ₺
DN 125	DN 125 (5")	FLANŞLI	PN 16	16.720 ₺
DN 150	DN 150 (6")	FLANŞLI	PN 16	28.208 ₺
DN 200	DN 200 (8")	FLANŞLI	PN 16	49.857 ₺

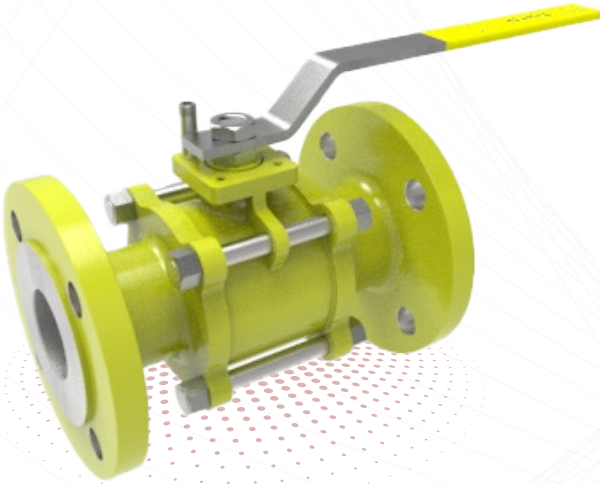



KALDE - DİŞLİ PİRİNÇ DOĞALGAZ VANALARI (TSE EN331)				
ÜRÜN	BOYUT	BAĞLANTI	BASINÇ	FİYAT
DN 15	DN 25 (1")	DİŞLİ	MOP 0.5-5	60,27 ₺
DN 20	DN 32 (1 1/4")	DİŞLİ	MOP 0.5-5	91,46 ₺
DN 25	DN 25 (1")	DİŞLİ	MOP 0.5-5	163,80 ₺
DN 32	DN 32 (1 1/4")	DİŞLİ	MOP 0.5-5	272,23 ₺
DN 40	DN 40 (1 1/2")	DİŞLİ	MOP 0.5-5	407,42 ₺
DN 50	DN 50 (2")	DİŞLİ	MOP 0.5-5	599,24 ₺



MONOBLOK İZOLASYON CONTASI				
ÜRÜN	BOYUT	BAĞLANTI	BASINÇ	FİYAT
DN 25	DN 25 (1")	Dişli	ANSI 150	98 €
DN 32	DN 32 (1 1/4")	Dişli	ANSI 150	154 €
DN 40	DN 40 (1 1/2")	Dişli	ANSI 150	163 €
DN 50	DN 50 (2")	Dişli	ANSI 150	173 €
DN 65	DN 65 (2 1/2")	Dişli	ANSI 150	220 €
DN 80	DN 80 (3")	Dişli	ANSI 150	280 €
DN 100	DN 100 (4")	Dişli	ANSI 150	400 €
DN 150	DN 150 (6")	Dişli	ANSI 150	733 €
DN 200	DN 200 (8")	Dişli	ANSI 150	1.105 €
DN 250	DN 250 (10")	Dişli	ANSI 150	2.046 €
DN 300	DN 300 (12")	Dişli	ANSI 150	2.558 €

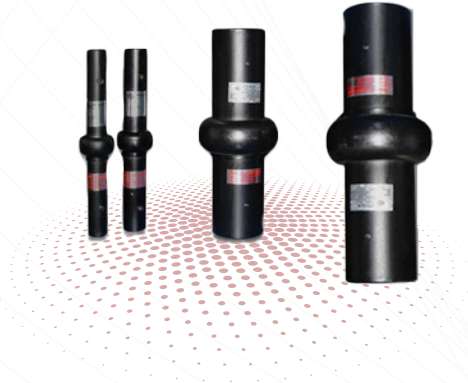

İZOLE MAFSALLAR (BOMBELİ)				
ÜRÜN	BOYUT	BAĞLANTI	BASINÇ	FİYAT
DN 25	DN 25 (1")	Dişli	PN 10	180 ₺
DN 32	DN 32 (1 1/4")	Dişli	PN 10	255 ₺
DN 40	DN 40 (1 1/2")	Dişli	PN 10	285 ₺
DN 50	DN 50 (2")	Dişli	PN 10	400 ₺
DN 65	DN 65 (2 1/2")	Dişli	PN 10	610 ₺
DN 80	DN 80 (3")	Dişli	PN 10	1.200 ₺
DN 100	DN 100 (4")	Dişli	PN 10	3.100 ₺

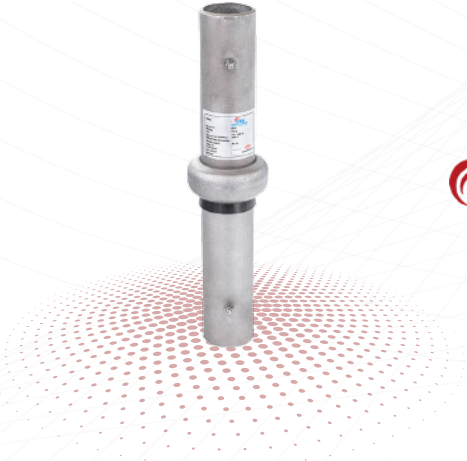

İZOLE MAFSALLAR (REKORLU)				
ÜRÜN	BOYUT	BASINÇ	PAKET ADEDİ	FİYAT
DN 25	DN 25 (1")	PN 10	25	210 ₺
DN 32	DN 32 (1 1/4")	PN 10	20	290 ₺
DN 40	DN 40 (1 1/2")	PN 10	15	330 ₺
DN 50	DN 50 (2")	PN 10	10	460 ₺
DN 65	DN 65 (2 1/2")	PN 10	5	680 ₺
DN 80	DN 80 (3")	PN 10	4	1.200 ₺
DN 100	DN 100 (4")	PN 10	-	3.100 ₺

**SANCAK - 30MM LAYNERSİZ DÖNER FLANŞLI KOMPANSATÖR**

ÜRÜN	BOYUT	BAĞLANTI	BASINÇ	FİYAT
DN 25	DN 25 (1")	FLANŞLI	PN 16	1.008 ₺
DN 32	DN 32 (1 1/4")	FLANŞLI	PN 16	1.028 ₺
DN 40	DN 40 (1 1/2")	FLANŞLI	PN 16	1.178 ₺
DN 50	DN 50 (2")	FLANŞLI	PN 16	1.479 ₺
DN 65	DN 65 (2 1/2")	FLANŞLI	PN 16	1.598 ₺
DN 80	DN 80 (3")	FLANŞLI	PN 16	1.942 ₺
DN 100	DN 100 (4")	FLANŞLI	PN 16	2.484 ₺
DN 125	DN 125 (5")	FLANŞLI	PN 16	3.307 ₺
DN 150	DN 150 (5")	FLANŞLI	PN 16	4.146 ₺
DN 200	DN 200 (8")	FLANŞLI	PN 16	6.585 ₺
DN 250	DN 250 (10")	FLANŞLI	PN 16	11.515 ₺

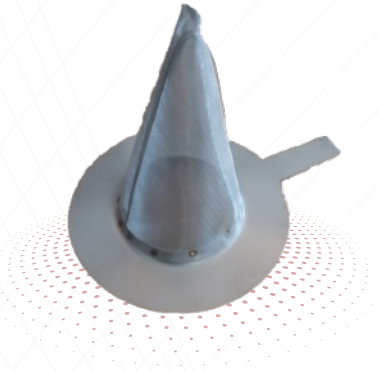

KONİK FİLTRE		
ÜRÜN	BOYUT	FİYAT
DN 40	DN 40 (1 1/2")	285 ₺
DN 50	DN 50 (2")	400 ₺
DN 65	DN 65 (2 1/2")	610 ₺
DN 80	DN 80 (3")	1.200 ₺
DN 100	DN 100 (4")	3.100 ₺
DN 125	DN 125 (5")	3.100 ₺



MANOMETRELER		
ÜRÜN	BOYUT	FİYAT
0-100 mbar	Ø 63	462,50 ₺
0-600 mbar	Ø 63	231,50 ₺
-	FARKLI ÇAPLAR İÇİN	FİYAT SORUNUZ



FRS/SAFEGAS GAZ ALARM CİHAZI

FİYAT

275 ₺

FRS/SAFEGAS GAZ ALARM CİHAZI EXPROOF

FİYAT

575 ₺



SİSMİK SİSCUT - GAZ ALARM CİHAZI-TEK ÇIKIŞ 12V

FİYAT

₺ 270

SİSMİK SİSLİFT - GAZ ALARM CİHAZI-ÇİFT ÇIKIŞ 12V/220V

FİYAT

₺ 285

SİSMİK NOFİRE - GAZ ALARM CİHAZI

FİYAT

FİYAT SORUNUZ



HONEYWELL/HEMAN - CO KARBONMANOMETRE CİHAZI

FİYAT

FİYAT SORUNUZ

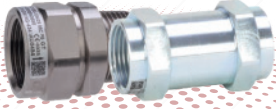

TAS 21 TERMİK DOĞALGAZ VANASI

ÜRÜN	BOYUT	BAĞLANTI	BASINÇ	FİYAT
DN 20	DN 20 (3/4")	DİŞLİ	MOP 5-20	25 €
DN 25	DN 20 (1")	DİŞLİ	MOP 5-20	35 €



TAS 22 TERMİK DOĞALGAZ VANASI

ÜRÜN	BOYUT	BAĞLANTI	BASINÇ	FİYAT
DN 32	DN 32 (1 1/4")	DİŞLİ	MOP 5-20	180 €
DN 40	DN 40 (1 1/2")	DİŞLİ	MOP 5-20	200 €
DN 50	DN 50 (2")	DİŞLİ	MOP 5-20	265 €

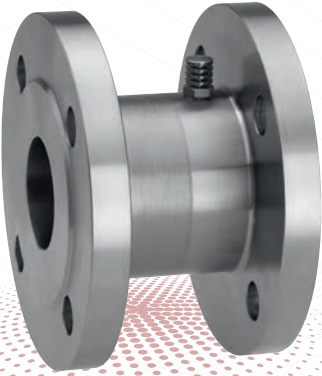

TAS 23 TERMİK DOĞALGAZ VANASI

ÜRÜN	BOYUT	BAĞLANTI	BASINÇ	FİYAT
DN 65	DN 65 (2 1/2")	DİŞLİ	MOP 5-20	1.600 €
DN 80	DN 80 (3")	DİŞLİ	MOP 5-20	1.920 €
DN 100	DN 100 (4")	DİŞLİ	MOP 5-20	3.200 €



MAGNEZYUM ANOT 2LB.

FİYAT

FİYAT SORUNUZ

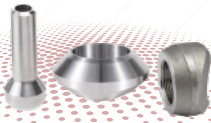

WELDOLET,THREDOLET,NİPOLET - 1/2"

FİYAT

FİYAT SORUNUZ

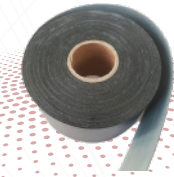

SICAK VE SOĞUK SARGI BANTLARI

FİYAT

FİYAT SORUNUZ



SIZDIRMAZLIK ÜRÜNLERİ

FİYAT

FİYAT SORUNUZ

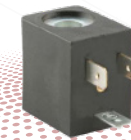

ÇELİK FİLTRE KARTUŞLARI

FİYAT

FİYAT SORUNUZ



REGÜLATÖR YEDEK KİTLERİ

FİYAT

FİYAT SORUNUZ



SELENOİD BOBİN VE SOKETLERİ

FİYAT

FİYAT SORUNUZ



DOĞALGAZ FLEXLER

FİYAT

FİYAT SORUNUZ



TOPRAKLAMA ÇUBUĞU

FİYAT

FİYAT SORUNUZ



Kale Kalıp

G4 DOĞALGAZ SAYACI - SETSİZ

FİYAT

50 €



elster
American Meter

G6 KÖRÜKLÜ DOĞALGAZ SAYACI - SETLİ

FİYAT

160 €

G10 KÖRÜKLÜ DOĞALGAZ SAYACI - SETLİ

FİYAT

410 €

G16 KÖRÜKLÜ DOĞALGAZ SAYACI - SETLİ

FİYAT

425 €

G25 KÖRÜKLÜ DOĞALGAZ SAYACI - SETLİ

FİYAT

710 €

Pietro Fiorentini



FIORENTINI - ROTARYMETRE				
ÜRÜN	BOYUT	BAĞLANTI	BASINÇ	FİYAT
G-25	DN 40 (1 1/2")	FLANŞLI	PN 16 / ANSI 150	1.454 €
G-40	DN 50 (2")	FLANŞLI	PN 16 / ANSI 150	1.511 €
G-65	DN 50 (2")	FLANŞLI	PN 16 / ANSI 150	1.638 €
G-100	DN 80 (3")	FLANŞLI	PN 16 / ANSI 150	1.927 €
G-160	DN 80 (3")	FLANŞLI	PN 16 / ANSI 150	2.383 €
G-250	DN 100 (4")	FLANŞLI	PN 16 / ANSI 150	3.286 €
G-400	DN 100 (4")	FLANŞLI	PN 16 / ANSI 150	6.012 €
G-400	DN 150 (6")	FLANŞLI	PN 16 / ANSI 150	6.295 €
G-650	DN 150 (6")	FLANŞLI	PN 16 / ANSI 150	7.308 €

elster
American Meter



ELSTER - ROTARYMETRE				
ÜRÜN	BOYUT	BAĞLANTI	BASINÇ	FİYAT
G-40	DN 50 (2")	FLANŞLI	PN 16 / ANSI 150	1.470 €
G-65	DN 50 (2")	FLANŞLI	PN 16 / ANSI 150	1.595 €
G-100	DN 80 (3")	FLANŞLI	PN 16 / ANSI 150	1.950 €
G-160	DN 80 (3")	FLANŞLI	PN 16 / ANSI 150	2.555 €
G-250	DN 100 (4")	FLANŞLI	PN 16 / ANSI 150	3.350 €
G-400	DN 100 (4")	FLANŞLI	PN 16 / ANSI 150	5.280 €
G-400	DN 150 (6")	FLANŞLI	PN 16 / ANSI 150	5.450 €
G-650	DN 150 (6")	FLANŞLI	PN 16 / ANSI 150	12.600 €

Pietro Fiorentini

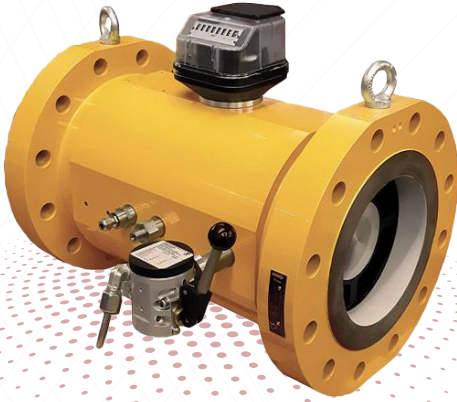

PIETRO FIORENTINI - TÜRBİNMETRE

ÜRÜN	BOYUT	BAĞLANTI	BASINÇ	FİYAT
G-40	DN 50 (2")	FLANŞLI	PN 16 / ANSI 150	1.979 €
G-65	DN 50 (2")	FLANŞLI	PN 16 / ANSI 150	1.979 €
G-100	DN 50 (2")	FLANŞLI	PN 16 / ANSI 150	1.979 €
G-100	DN 80 (3")	FLANŞLI	PN 16 / ANSI 150	2.552 €
G-160	DN 80 (3")	FLANŞLI	PN 16 / ANSI 150	2.375 €
G-250	DN 80 (3")	FLANŞLI	PN 16 / ANSI 150	2.375 €
G-400	DN 80 (3")	FLANŞLI	PN 16 / ANSI 150	2.552 €
G-160	DN 100 (4")	FLANŞLI	PN 16 / ANSI 150	2.814 €
G-250	DN 100 (4")	FLANŞLI	PN 16 / ANSI 150	2.814 €
G-400	DN 100 (4")	FLANŞLI	PN 16 / ANSI 150	2.814 €
G-650	DN 100 (4")	FLANŞLI	PN 16 / ANSI 150	3.326 €
G-400	DN 150 (6")	FLANŞLI	PN 16 / ANSI 150	4.282 €
G-650	DN 150 (6")	FLANŞLI	PN 16 / ANSI 150	4.282 €
G-1000	DN 150 (6")	FLANŞLI	PN 16 / ANSI 150	4.282 €
G-1600	DN 150 (6")	FLANŞLI	PN 16 / ANSI 150	4.376 €

elster
American Meter

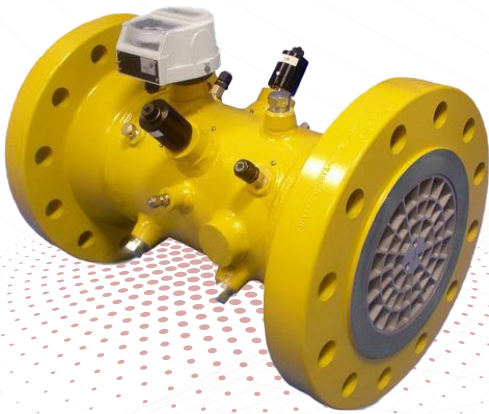

ELSTER - TÜRBİNMETRE

ÜRÜN	BOYUT	BAĞLANTI	BASINÇ	FİYAT
G-65	DN 50 (2")	FLANŞLI	PN 16 / ANSI 150	2.310 €
G-100	DN 80 (3")	FLANŞLI	PN 16 / ANSI 150	2.360 €
G-160	DN 80 (3")	FLANŞLI	PN 16 / ANSI 150	2.460 €
G-250	DN 80 (3")	FLANŞLI	PN 16 / ANSI 150	2.810 €
G-160	DN 100 (4")	FLANŞLI	PN 16 / ANSI 150	3.100 €
G-250	DN 100 (4")	FLANŞLI	PN 16 / ANSI 150	3.490 €
G-400	DN 100 (4")	FLANŞLI	PN 16 / ANSI 150	3.720 €
G-400	DN 150 (6")	FLANŞLI	PN 16 / ANSI 150	5.870 €
G-650	DN 150 (6")	FLANŞLI	PN 16 / ANSI 150	5.890 €
G-1000	DN 150 (6")	FLANŞLI	PN 16 / ANSI 150	6.100 €



PIETRO FIORENTINI - QUANTOMETRE				
ÜRÜN	BOYUT	BAĞLANTI	BASINÇ	FİYAT
G-40	DN 50 (2")	FLANŞLI	PN 16 / ANSI 150	1.625 €
G-65	DN 50 (2")	FLANŞLI	PN 16 / ANSI 150	1.625 €
G-100	DN 50 (2")	FLANŞLI	PN 16 / ANSI 150	1.625 €
G-100	DN 80 (3")	FLANŞLI	PN 16 / ANSI 150	1.813 €
G-160	DN 80 (3")	FLANŞLI	PN 16 / ANSI 150	1.813 €
G-250	DN 80 (3")	FLANŞLI	PN 16 / ANSI 150	1.813 €
G-400	DN 80 (3")	FLANŞLI	PN 16 / ANSI 150	1.813 €
G-160	DN 100 (4")	FLANŞLI	PN 16 / ANSI 150	2.314 €
G-250	DN 100 (4")	FLANŞLI	PN 16 / ANSI 150	2.314 €
G-400	DN 100 (4")	FLANŞLI	PN 16 / ANSI 150	2.314 €
G-650	DN 100 (4")	FLANŞLI	PN 16 / ANSI 150	2.314 €



ELSTER - TÜRBİNMETRE				
ÜRÜN	BOYUT	BAĞLANTI	BASINÇ	FİYAT
QA10	DN 25 (1")	FLANŞLI	PN 4	980 €
QA16	DN 25 (1")	FLANŞLI	PN 4	1.110 €
QA25	DN 25 (1")	FLANŞLI	PN 4	1.245 €
QA40	DN 25 (1")	FLANŞLI	PN 4	1.430 €
QA40	DN 40 (1 1/2")	FLANŞLI	PN 4	1.910 €
QA65	DN 50 (2")	FLANŞLI	PN 4	2.260 €
QA100	DN 80 (3")	FLANŞLI	PN 4	2.335 €
QA160	DN 80 (3")	FLANŞLI	PN 4	2.490 €
QA250	DN 80 (3")	FLANŞLI	PN 4	2.560 €
QA250	DN 100 (4")	FLANŞLI	PN 4	3.020 €
QA400	DN 100 (4")	FLANŞLI	PN 4	3.240 €
QA400	DN 150 (6")	FLANŞLI	PN 4	3.880 €
QA650	DN 150 (6")	FLANŞLI	PN 4	4.240 €
QA1000	DN 150 (6")	FLANŞLI	PN 4	4.650 €

ELSTER - TÜRBİNMETRE				
ÜRÜN	BOYUT	BAĞLANTI	BASINÇ	FİYAT
QA10	DN 25 (1")	FLANŞLI	PN 16	1.050 €
QA16	DN 25 (1")	FLANŞLI	PN 16	1.200 €
QA25	DN 25 (1")	FLANŞLI	PN 16	1.320 €
QA40	DN 25 (1")	FLANŞLI	PN 16	1.520 €
QA40	DN 40 (1 1/2")	FLANŞLI	PN 16	2.150 €
QA65	DN 50 (2")	FLANŞLI	PN 16	2.400 €
QA100	DN 80 (3")	FLANŞLI	PN 16	2.480 €
QA160	DN 80 (3")	FLANŞLI	PN 16	2.620 €
QA250	DN 80 (3")	FLANŞLI	PN 16	2.700 €
QA250	DN 100 (4")	FLANŞLI	PN 16	3.200 €
QA400	DN 100 (4")	FLANŞLI	PN 16	3.400 €
QA400	DN 150 (6")	FLANŞLI	PN 16	4.150 €
QA650	DN 150 (6")	FLANŞLI	PN 16	4.400 €
QA1000	DN 150 (6")	FLANŞLI	PN 16	4.860 €

ELSTER - TÜRBİNMETRE				
ÜRÜN	BOYUT	BAĞLANTI	BASINÇ	FİYAT
Q65	DN 50 (2")	FLANŞLI	PN 10	1.875 €
Q100	DN 80 (3")	FLANŞLI	PN 10	2.070 €
Q160	DN 80 (3")	FLANŞLI	PN 10	2.185 €
Q250	DN 80 (3")	FLANŞLI	PN 10	2.300 €
Q250	DN 100 (4")	FLANŞLI	PN 10	2.620 €
Q400	DN 100 (4")	FLANŞLI	PN 10	2.750 €
Q400	DN 150 (6")	FLANŞLI	PN 10	4.230 €
Q650	DN 150 (6")	FLANŞLI	PN 10	4.290 €
Q1000	DN 150 (6")	FLANŞLI	PN 10	4.520 €

ELSTER - TÜRBİNMETRE				
ÜRÜN	BOYUT	BAĞLANTI	BASINÇ	FİYAT
Q65	DN 50 (2")	FLANŞLI	PN 16 / ANSI 150	2.020 €
Q100	DN 80 (3")	FLANŞLI	PN 16 / ANSI 150	2.290 €
Q160	DN 80 (3")	FLANŞLI	PN 16 / ANSI 150	2.400 €
Q250	DN 80 (3")	FLANŞLI	PN 16 / ANSI 150	2.600 €
Q250	DN 100 (4")	FLANŞLI	PN 16 / ANSI 150	2.800 €
Q400	DN 100 (4")	FLANŞLI	PN 16 / ANSI 150	2.950 €
Q400	DN 150 (6")	FLANŞLI	PN 16 / ANSI 150	4.450 €
Q650	DN 150 (6")	FLANŞLI	PN 16 / ANSI 150	4.50 €
Q1000	DN 150 (6")	FLANŞLI	PN 16 / ANSI 150	4.750 €



FRS 3/40.2 365/280/210 380 V TRİFAZE DN 40

FİYAT

FİYAT SORUNUZ

FRS 3/50.2 926/770/516 380 V TRİFAZE DN 50

FİYAT

FİYAT SORUNUZ

FRS 3/65.2 1390/945/546 380 V TRİFAZE DN 65

FİYAT

FİYAT SORUNUZ

FRS 3/80.2 1360/950/670 380 V TRİFAZE DN 80

FİYAT

FİYAT SORUNUZ

FRS 25/6 33-44 WATT 220 V MONOFAZE DN 25

FİYAT

\$ 82,50

FRS 25/8 43-80 WATT 220 V MONOFAZE DN 25

FİYAT

\$ 110,00

FRS 32/8 57-94 WATT 220 V MONOFAZE DN 32

FİYAT

\$ 137,50



FRS 4/4 85-550 WATT 220 V MONOFAZE DN 40

FİYAT

FİYAT SORUNUZ

FRS 4/12 150-710 WATT 220 V MONOFAZE DN 40

FİYAT

FİYAT SORUNUZ

FRS 5/8 245-970 WATT 220 V MONOFAZE DN 50

FİYAT

FİYAT SORUNUZ

FRS 5/12 285-1085 WATT 220 V MONOFAZE DN 50

FİYAT

FİYAT SORUNUZ

FRS 6/12 305-1100 WATT 220 V MONOFAZE DN 65

FİYAT

FİYAT SORUNUZ

FRS 8/12 485-1600 WATT 220 V MONOFAZE DN 80

FİYAT

FİYAT SORUNUZ